



LiFePO4 Battery

User Manual



Table of Contents

Overview	1
Scope	1
Intended Audience	1
Manual Usage	1
Product Introduction	1
Introduction	1
Safety Instructions	2
Labeling Explanation	2
Installation Tools	2
Precautions	3
Manual Storage	3
Label Protection	3
Safety Warning Labels	3
Personnel Requirements	3
Power-On Measurement	4
Measuring Instruments	4
Maintenance and Inspection	4
Overview of Main Components	5
Product Introduction	6
Overview	6
Advantages	6
Product Appearance	7
Product Model	7
Port Panel	8
Principle and Structure	9
Operating Principle	9
Connection Structure	9
Battery Installation and Wiring	10
Tool Preparation for Installation	10
Installation Preparation	10
Installation Notes	10
Installation Steps	11
Electrical Connection	12
Parallel Wiring:	13
Debugging	14
RS485 & CAN Port Definition	14
Upper Computer Software Operation Guide	15
ADS DIP Switch Definitions	18
Battery Parallel Connection DIP Switch Diagram	19
Power-On Sequence	20
Common Issues and Solutions	20
Inverter Matching Information	21
Maintenance	22

Overview

◆ Scope

This user manual provides information, operating instructions, and maintenance guidelines for the **NADDEX** Energy low-voltage residential energy storage battery series. The **NADDEX** Energy residential energy storage series is a lithium battery system developed by **NADDEX** Energy designed to be compatible with various inverter brands available in the market.

◆ Intended Audience

This manual is intended for professional technical personnel involved in the installation, operation, and maintenance of lithium batteries, as well as end-users seeking technical information.

◆ Manual Usage

1. Before using the product, carefully review this user manual and keep it in a readily accessible location.
2. All information in this user manual, including images and symbols, is proprietary to **NADDEX**. Unauthorized use of any part or all of the content is strictly prohibited for individuals outside the company.
3. Considering the potential for updates and corrections to the manual content, users are advised to use the provided documentation as a reference. For the latest user manual, please refer to the product documentation provided or contact customer service through the official website.

Product Introduction



◆ Introduction

1. The **NADDEX** residential energy storage series is a battery module developed by **NADDEX** for low-voltage lithium battery systems, primarily applied in the field of residential energy storage. It can achieve high-precision multi-cell voltage and temperature acquisition.
2. The module adopts a passive balancing method, improving the overall lifespan of the battery pack.
3. The module features external communication interfaces using CAN, RS485, and dry contact communication methods, allowing communication in parallel for up to 16 batteries.
4. Embedded BMS system effectively monitors phenomena such as over-temperature, over-voltage, and over-current, reducing the risk of battery damage or even fire, ensuring the safety of life and property.
5. This manual introduces the types, sizes, performance, technical characteristics, warnings and precautions of lithium battery systems. This specification is only applicable to the battery systems provided by **NADDEX**.

Safety Instructions











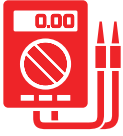

◆ Labeling Explanation

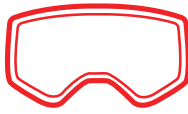
To ensure user safety during product use, relevant labeling information with appropriate symbols is provided in this manual. The following lists symbols that may be used in this manual, so please read carefully.

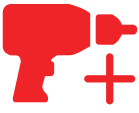
Icon	Description
	Signifies a low-level potential hazard. Failure to avoid may result in minor or moderate injury to personnel.
	Indicates the presence of high voltage inside the battery module. Touching may lead to electric shock hazards.
	This is the ground protection port (PE). It should be securely grounded to ensure the safety of operating personnel.

◆ Installation Tools

Prior to installation, prepare the following tools:

Category	Description		
General Tools	 Multimeter	 Protective gloves	 Insulated safety shoes
	 Protective clothing	 Safety goggles	 Antistatic wrist strap
Installation Tools	 Electric screwdriver	 Socket wrench	 Wire stripper
	 Phillips screwdriver (M4/M6)	 Electric drill	 Hammer

Precautions

◆ Manual Storage

- 1.This manual covers crucial information for the **NADDEX** Home Energy Storage Series. Prior to operating the product, carefully read this manual as it provides essential assistance in acquainting you with the product.
- 2.Store this manual securely for the convenience of relevant installation and maintenance personnel to refer to during operations.
- 3.Strictly follow the descriptions in this manual when operating the **NADDEX** Home Energy Storage Series to avoid equipment damage, injuries, property loss, and other potential issues.

◆ Label Protection

- 1.Warning labels on the **NADDEX** Home Energy Storage Series contain crucial safety operation information. It is strictly prohibited to intentionally tear or damage them!
- 2.The product has a nameplate on the casing, providing essential parameter information. It is strictly prohibited to intentionally tear or damage it!

◆ Safety Warning Labels

When conducting installation, routine maintenance, inspections, etc., on the **NADDEX** Home Energy Storage Series, to prevent unauthorized individuals from approaching, engaging in improper operations, or accidents, adhere to the following conventions:

- 1.Erect clear signage at the switch locations of the **NADDEX** products to prevent accidents caused by accidental closing.
- 2.Set warning signs or establish safety warning tape near the operating area to prevent unrelated personnel from approaching.
- 3.After maintenance or inspection, conduct a thorough on-site safety check.

◆ Personnel Requirements

- 1.Only personnel with relevant professional qualifications are allowed to perform various operations on this product.
- 2.Operating personnel should be thoroughly familiar with the composition and working principles of the entire **NADDEX** Home Energy Storage Series system.
- 3.Operating personnel should be fully acquainted with the "User Manual" for this product.

Precautions

◆ Power-On Measurement



After the energy storage battery is installed, there is a high voltage present, and accidental contact with the positive and negative terminals may result in electric shock injuries. Therefore, when conducting power-on measurements, attention should be paid to the following:

1. Take necessary insulation protection measures (such as wearing insulated gloves).
2. Accompanying personnel must be present to ensure personal safety.

◆ Measuring Instruments



When performing electrical connections and trial operations on the energy storage backup battery, and to ensure that electrical parameters meet requirements, relevant electrical measuring equipment such as multimeters, power meters, etc., should be used. Note the following:

1. Use measuring equipment with a suitable range that conforms to on-site working conditions.
2. Ensure the correct and standardized electrical connections of the instruments to avoid dangers such as electric arcs.

◆ Maintenance and Inspection









When both the energy storage battery and the inverter are turned off, and electrical connections are confirmed to be disconnected, maintenance or inspection operations can be carried out on the energy storage battery cabinet. Pay attention to the following:

1. Ensure that the energy storage battery will not be accidentally re-energized.
2. Use a multimeter to ensure that the energy storage battery is completely de-energized.
3. For parts near potentially live components during operations, use insulating materials for insulation covering or grounding.
4. It is strictly prohibited to perform maintenance or inspection operations on live equipment!

When performing maintenance or inspection on equipment, it must be ensured that at least two personnel are present at the site. Maintenance operations can only be carried out after the equipment is safely de-energized, fully charged, or discharged.

Overview of Main Components

◆ Product configuration list

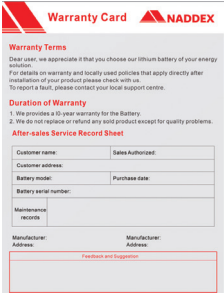
No.	Image	Name	Qty	No.	Image	Name	Qty
1		Battery	1	2		Communication Cable	2
3		Orange-Positive Power Line	1	4		Expansion Bolt	9
5		Black-negative Power Line	1	6		Product User Manual	1
7		Warranty Card	1				

The product configuration list is subject to change without prior notice.

Product Introduction

◆ Overview

The **NADDEX** household energy storage series lithium battery module integrates **NADDEX** high-capacity, high-safety lithium iron phosphate battery cells. It adopts a stacked design with advantages in footprint and vertical space utilization. The module incorporates a high-precision Battery Management System (BMS) unit, monitoring and collecting real-time data on voltage and temperature inside the module. This enables intelligent temperature control at the cell level and smart cell balancing, enhancing system efficiency and battery cycle life. The module features a shock-resistant structure within a cold-rolled sheet metal shell for high safety and reliability, meeting household standards. Additionally, the module is designed for high stability and disturbance resistance, ensuring the safe and reliable operation of the battery system.

◆ Advantages

- The positive electrode material of the battery is lithium iron phosphate (LiFePO₄) material, which has good safety performance, has a cycle life of more than 6,500 times.
- The high-performance intelligent management system is adopted to realize comprehensive state control of battery charging, discharging, floating charging and hibernation, and multi-level protection is set for voltage, current, temperature, etc., so that the battery is always in an ideal state.
- It has a comprehensive monitoring system to monitor the voltage, current, temperature, capacity and working status of the battery.
- The system adopts an intelligent design method to meet the four remote control standards of the national standard: telemetry, remote signaling, remote control, and remote adjustment.
- Built-in intelligent balance module to ensure the capacity consistency of the battery pack during long-term use and prolong the service life.
- The control panel includes status display and alarm devices, which can visually see the working status and alarm information of the battery.
- The system has its own intelligent thermal management device, which can work in a wide temperature range.

Product Appearance

Product Model

The technical parameters of LiFePO4 Battery Energy Storage System are shown in Table 1 below:

Items	25.6V280Ah	51.2V100Ah	51.2V200Ah	51.2V280Ah	51.2V300Ah
Rated Voltage (V)	25.6	51.2	51.2	51.2	51.2
Nominal capacity (Ah)	280	100	200	280	300
Energy (kWh)	7.17	5.12	10.24	14.34	15.36
Size (L*W*Hmm)	530*413*233	650*384*142	680*412*231	825*413*233	825*413*233

Control Panel

LiFePO4 Battery Energy Storage System adopts the same control panel structure as Figure 2,



- ① Metal case (SPCC)
- ② Positive Terminal
- ③ Negative Terminal
- ④ RST Button
- ⑤ RUN & ALARM Lighting
- ⑥ SOC Display Lighting
- ⑦ Dry Contact
- ⑧ Communication Port
- ⑨ Metal Handle
- ⑩ LCD Display Screen

Figure 2 Control Panel Illustration (Reference Picture)

Remark: All LiFePO4 battery energy storage system with wall mounted type, different panel place, LCD display shown in battery pack have same functions.

Port Panel

No.	Name	Function	Notes
1	Metal Case (SPCC)	Painted metal casing	
2	Negative Terminal Port (+)	Battery Positive Output	
3	Negative Terminal Port (-)	Battery Negative Output	
4	Reset Button (RST)	Battery Reset	Briefly tap and release within 1-3 seconds.
5	Operation Light (RUN) Alarm Light (ALM)	Battery Operation Indicator Light Battery Alarm Indicator Light	
6	Capacity Light (CAPACITY)	Battery Capacity Indicator Light	
7	Dry Contact	Dry Contact Communication	1. Dry Contact 1 - PIN1 to PIN2: Normally open, closed during fault protection; 2. Dry Contact 2 - PIN3 to PIN4: Normally open, closed during low battery alarm.
8	RS485A & CAN	485 Communication Interface CAN Communication Interface	Communication with inverter via RS485 Communication with inverter via CAN
8	RS232	1. Monitor batteries and modify parameters. 2. Perform software upgrades.	
8	RS485B	Communication between batteries	Functions are the same, no distinction between left and right.
9	Metal Handle	Battery Metal Handle	
10	LCD Display Screen	Touch Display	
11	Vents	Used for battery ventilation and heat dissipation	
12	Universal Wheel	Convenient battery relocation	
13	Ground Terminal Port	Battery Ground	

Principle and Structure

◆ Operating Principle

Working principle for Residential LiFePO₄ Battery Energy Storage System: Connect battery pack in parallel to the DC output end of the inverter of the energy storage device. When the mains power supply is normal, the inverter module works normally to supply power to the equipment (the load in the figure) and charge the battery pack; when the utility power and photovoltaic power are cut off, the battery pack provides uninterrupted power supply to the inverter to ensure the normal operation of household electricity; When power is turned on again, the battery pack is charged while power is restored to the household loads.

◆ Connection Structure

The connection diagram of residential LiFePO₄ battery energy storage system is shown in Figure 1 below:

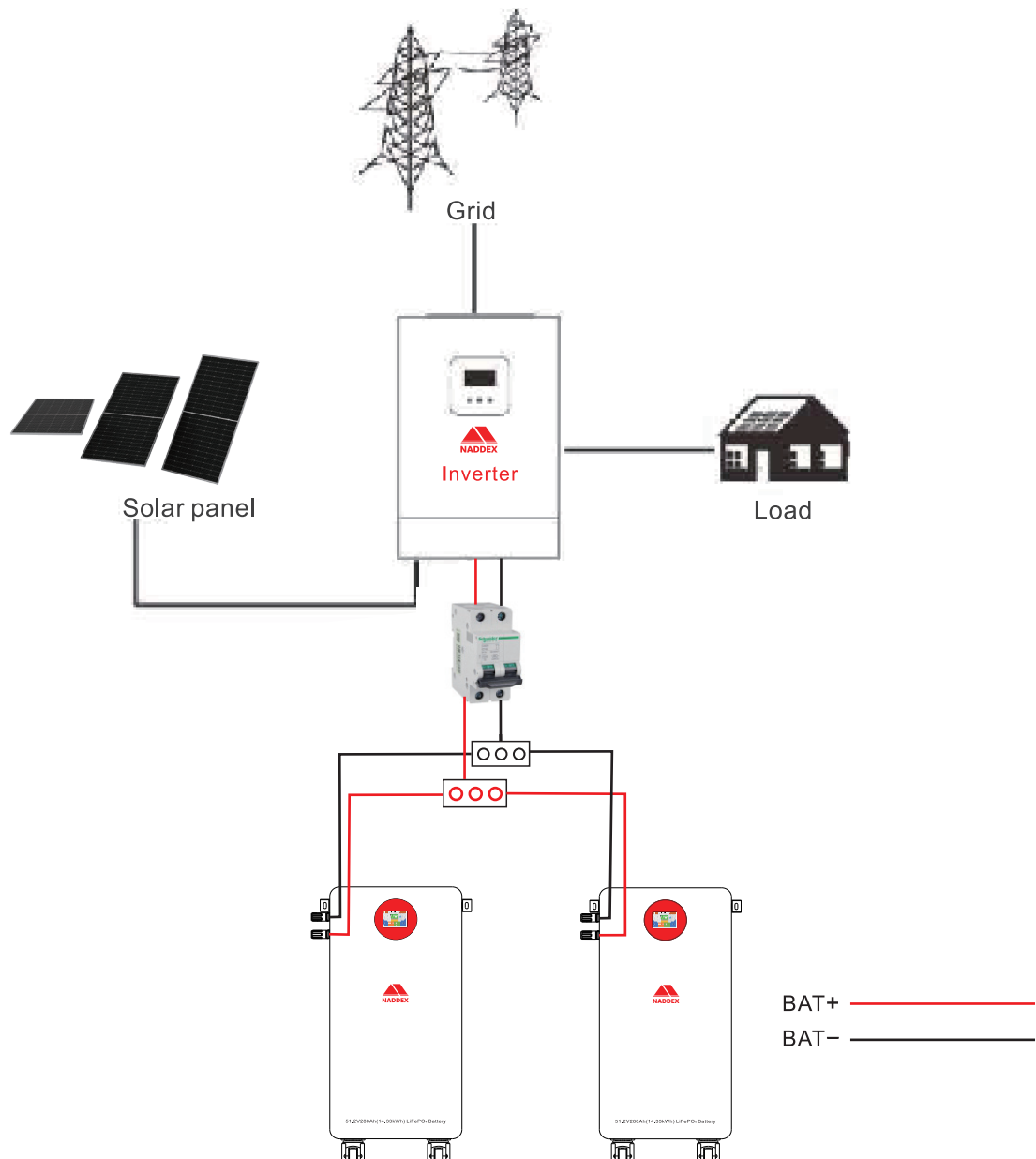

Figure 1 Operation Principle Diagram of Battery System

Battery Installation and Wiring

◆ Tool Preparation for Installation

Tools Required: Electric drill, hammer, wrench, M8*60 expansion bolt, Phillips screwdriver, multimeter, insulated gloves, Ethernet cable, power cable.

◆ Installation Preparation

Safety Regulations

The installation, operation and maintenance of LiFePO₄ Battery Energy Storage System should only be carried out by trained and qualified professionals. Before installation and use, please read the safety precautions and related operating procedures of this product carefully. The installation process must strictly abide by the following safety regulations and local safety regulations, otherwise it may cause personal injury or product damage.

- ⌚ Please ensure that the inverter connected to the battery is a qualified power system;
- ⌚ When installing the battery, please ensure that the power system is turned off and the battery pack is turned off;
- ⌚ All power-saving cables must have corresponding insulation measures, and it is strictly forbidden to expose the power cord;
- ⌚ Ensure that the battery and the power system are reliably grounded during installation.

◆ Installation Notes

- When begin to install the battery system, you should pay attention to the following matters:
- Installation space and load bearing. Make sure that there are sufficient fixed components to install the battery system, and to ensure that the battery mounting bracket or the cabinet be strong enough to bear the weight.
- Cable specifications. To ensure that the use of the connection of the power supply line can meet the maximum current requirements of equipment operation.
- Project layout. Ensure the whole construction process of power equipment, batteries and other reasonable layout.
- Wiring layout. Ensure that the wiring reasonable, orderly; and consider the moisture-proof, corrosion prevention.
- The whole installation process should wear anti-static wristband.
- The installation site should be at least two or more peoples to operate.
- Please ensure the installation site safe before installation.

◆ Installation Steps

- Select a suitable solid wall with a thickness greater than 150mm;
- Refer to the fixing distance of the mounting bracket bolts, and mark the hole position on the wall;
- Drill 9 holes according to the hole position, the depth is ≥ 80 mm;
- Mount the M8 expansion bolts in the upper holes and screw on the nuts;

◆ Installation Steps

- Fix the mounting bracket on the wall with expansion bolts;
- Under the condition of keeping the battery vertical, raise the battery to a position slightly higher than the mounting bracket, and hang the battery on the mounting bracket.

Step No.	Name	Definition
1	Turn off power supply	The system should be powered off, to ensure that there is no electric in installation process
2	Mechanical installation	1. Mounting lugs installation 2. Battery fixed installation
3	Electrical installation	1. Grounding cable 2. Power cable installation 3. Connecting equipment installation 4. Communication cable installation
4	Electrical commissioning	Power system commissioning

Step1.Interruption Of Power Supply

Before installation, please ensure the battery is powered off, at the same time, shutdown the equipment which need to connect to the battery.

Step2.Preparation before Installation

- 1.Installation of the mounting bracket. The device is packaged with an attached mounting wall bracket. Before installing the battery, fix the mounting bracket on the wall to ensure that the installation is tight.
- 2.Fixed battery installation. Secure the battery module to the mounting bracket to ensure that the battery pack is securely installed.
- 3.Expansion bolt installation diagram.

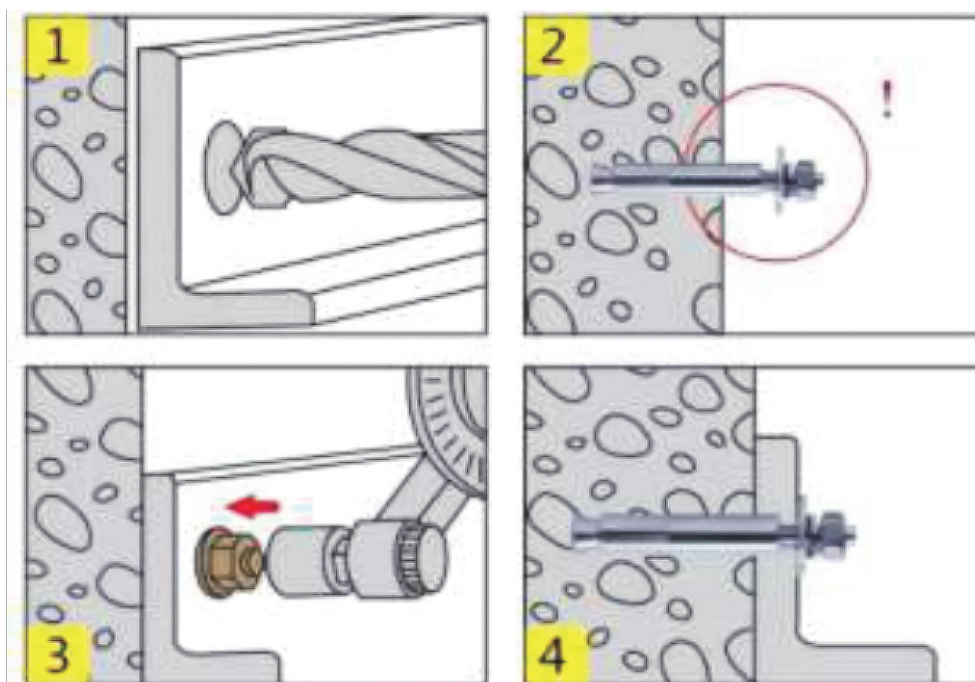

NOTICE:

1. In order to avoid electric shock or other injuries, check whether the existing electronic plumbing installation is compliant before drilling.
2. The battery is heavy, please handle it with care, so as not to damage the product or injure the installer.

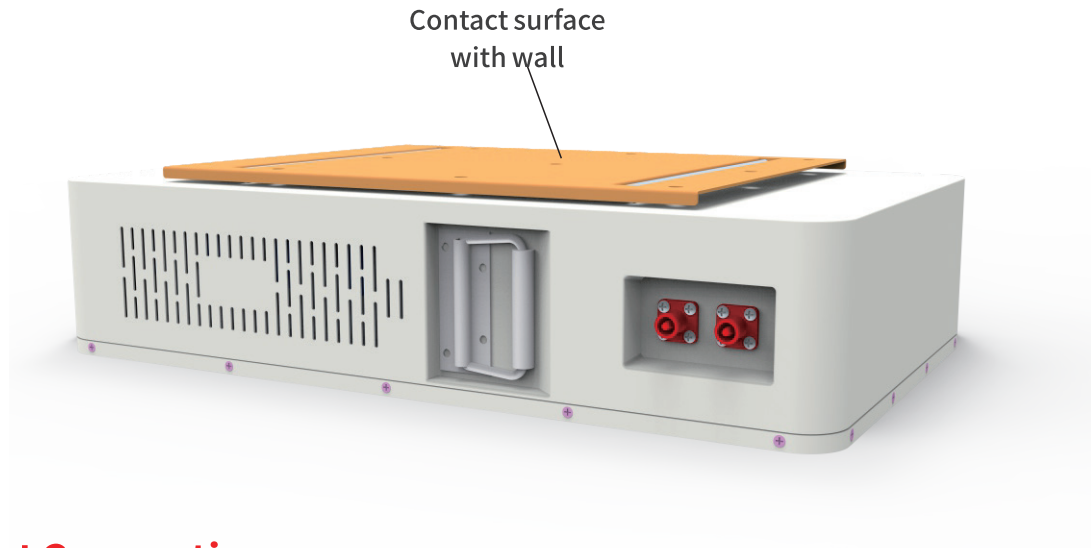

◆ Electrical Connection

Single Unit Wiring:

- Step 1. Connect the positive and negative terminals of the battery to the positive and negative terminals of the inverter using the power cable.
- Step 2. Complete the battery's grounding connection by using the ground wire.
- Step 3. Connect the RS485A (or CAN) port of the battery to the RS485 (or CAN) communication port of the inverter using the communication cable.
- Step 4. If used as a single unit, set the ADS dip switch to 1. Refer to section for dip switch rules.

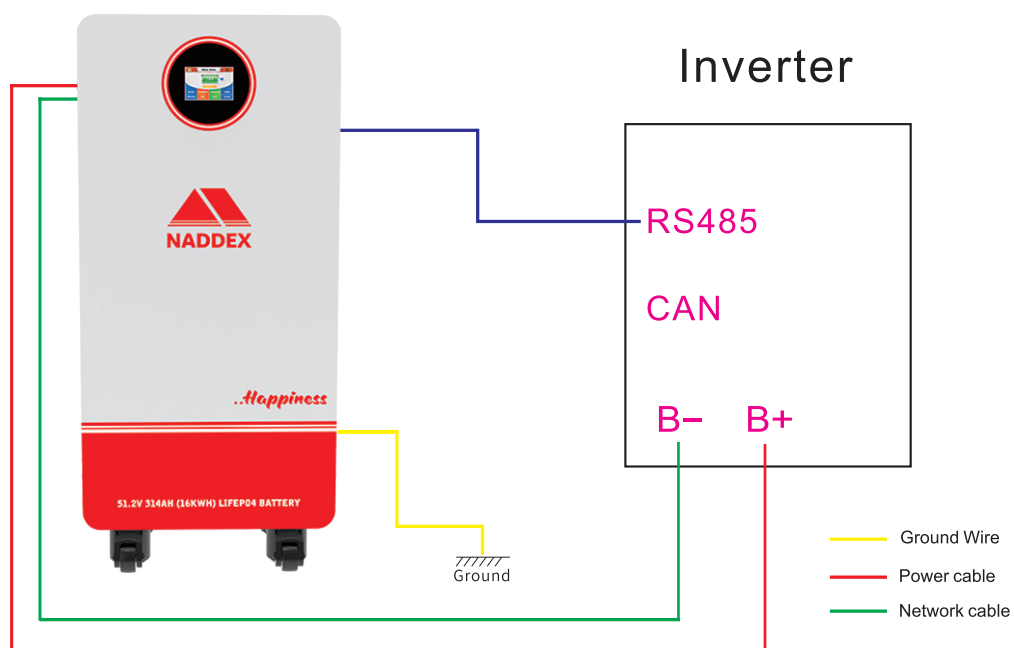

Parallel Wiring:

If multiple batteries are used in parallel, manually press the low-voltage switch (ON/OFF) first. Use a multimeter to check if the voltage of each battery is consistent. If consistent, turn off the batteries and proceed with cable connections, as shown in the schematic diagram (using two batteries in parallel as an example).

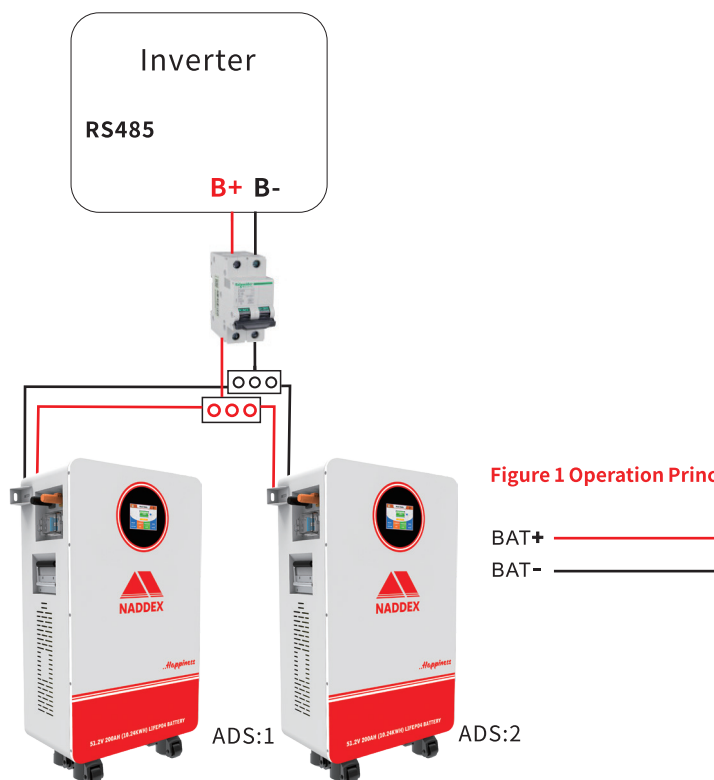

- Step 1. Connect the positive terminal of the battery using the power cable, and then connect the negative terminal of the battery using the power cable.
- Step 2. Connect the RS485B communication interface of adjacent batteries with communication cables (RS485B battery parallel ports have the same functionality and are not distinguished).
- Step 3. Connect the ground wire to the grounding point for all batteries. There is a ground symbol in the lower-left corner of the battery; attach the ground wire terminal to this point.
- Step 4. Use a standard Category 6 cable. Connect one end to the RS485A (or CAN) communication interface of the battery and the other end to the RS485 (or CAN) interface of the inverter (Note: the pin definition of the inverter communication should match that of the battery; refer to section for battery-to-inverter pin definitions).
- Step 5. Connect the positive terminal (+) of the first battery to the positive terminal interface of the inverter using the power cable. Then, connect the negative terminal (-) of the last battery to the negative terminal interface of the inverter using the power cable.

NOTICE:

- The battery directly connected to the inverter via the communication cable is defined as the host. The host dip switch is set to 1 and needs to be switched before powering on.
- Define dip switches for other batteries sequentially from 2 to 15. Avoid duplicating dip switch settings to 1.

Debugging

◆ RS485 & CAN Port Definition

1. Definition of RS485A port (default baud rate 9600bps) for communication between the battery and the inverter.

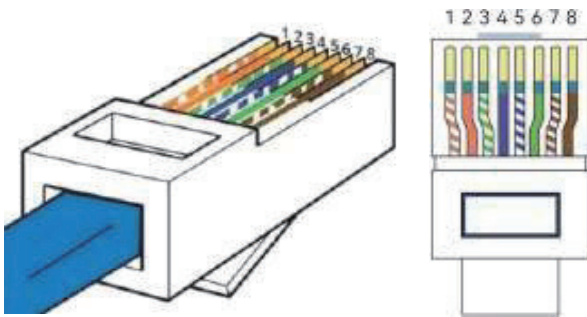

PIN2/7 (white & orange)	485-A
PIN1/8 (orange)	485-B

NOTICE:

- The default RS485 protocol for the battery is set to Pylontech RS485 (V3.5) protocol. If compatibility with other inverters is needed, it is necessary to communicate through RS232 with the host computer to change the default protocol.

2. Definition of CAN port (default baud rate is 500K) for communication between the battery and the inverter.

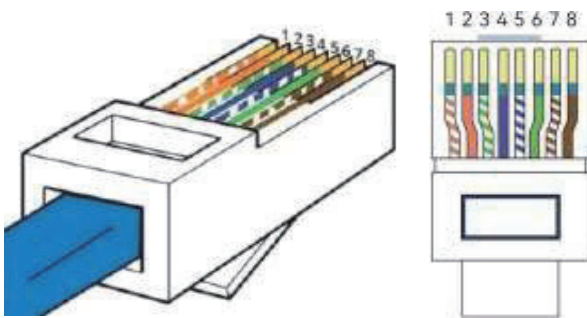

PIN4(blue): CANH; PIN5(blue & white): CANL

NOTICE:

- The battery is factory-set with the default CAN protocol, defaulting to Pylontech CAN (V1.2) protocol. If compatibility with other inverters is required, it is necessary to communicate through RS232 with the upper computer to change the default protocol.

Tip:



- For battery and inverter communication, choose either RS485 or CAN.

Interface Introduction

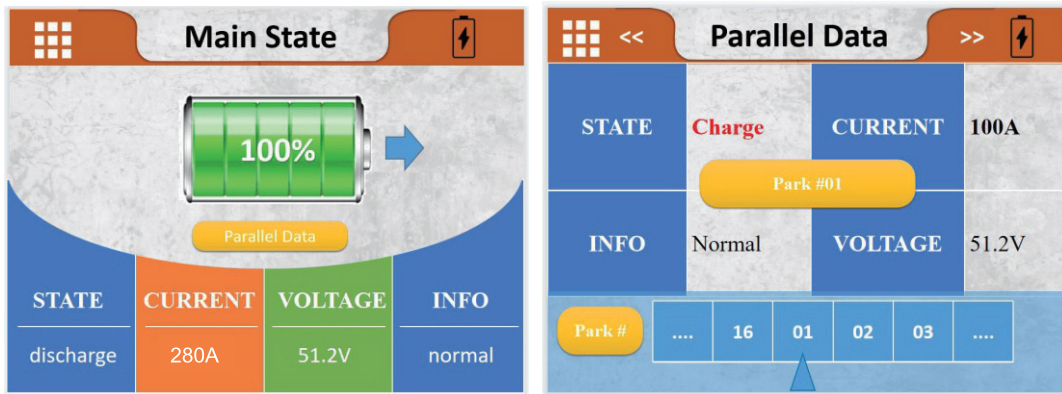
◆ Settings

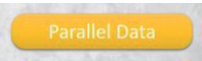

1) Icon Description:

	Main Menu Icon, click to enter the HOME interface
	Main State Icon, click to enter the Main State interface
	Parallel Data Icon, click to enter the Parallel Data interface

2) HOME Page

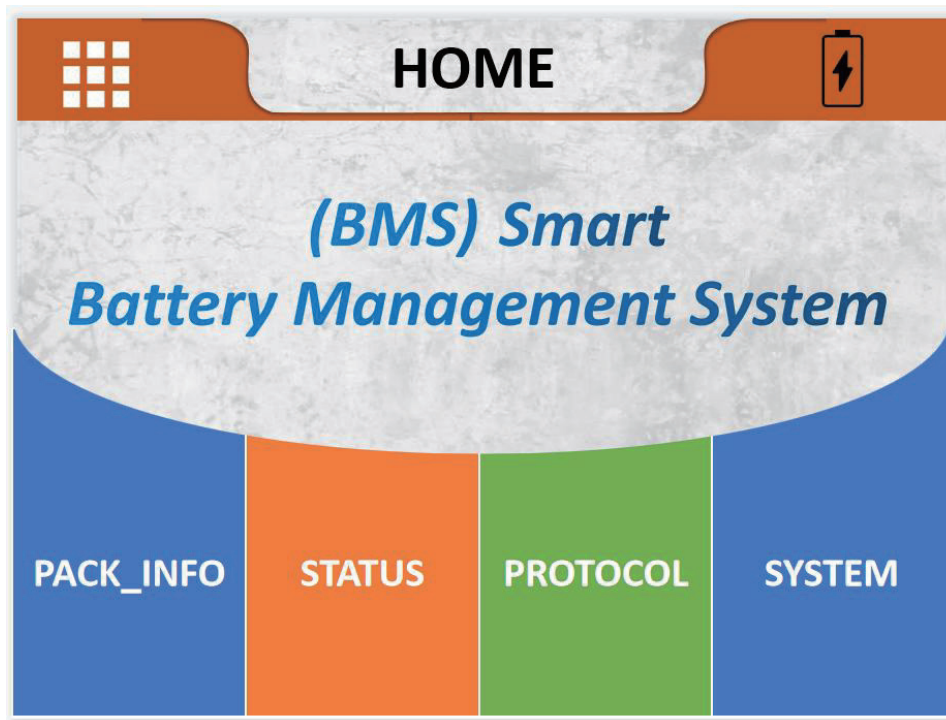

3) System Settings Page

Interface Introduction

◆ Settings

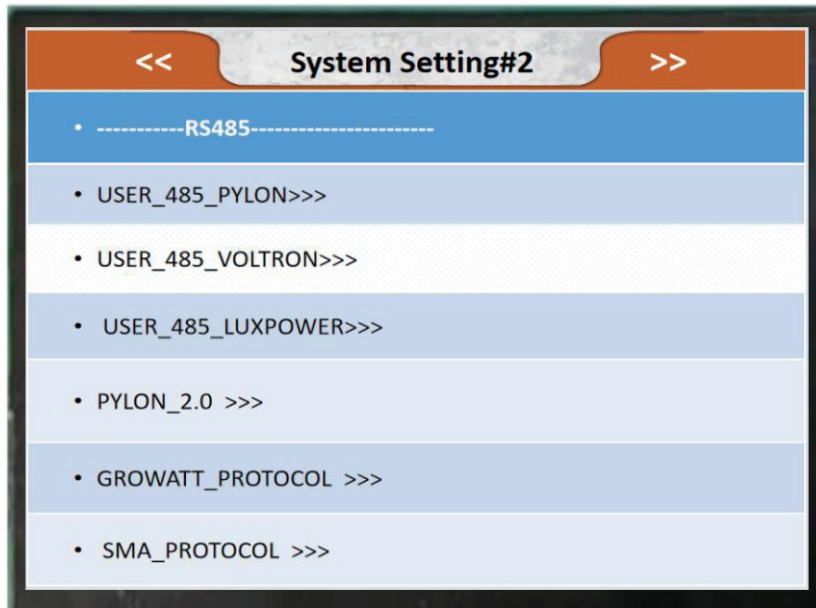

Menu :

CTP28/35-1.1

min state page

WAIT for 5s to show min state page

Total SOC

Current

Voltage

Warranty

HOME

PACK Info

Pack V

Im

Temperature

cell voltage

cell cap city

BMS Status

Packs status

Protect

Warning

Fault

PROTOCOL

CAN

SO FAR PROTOCOL

SoFar Energy BMS CAN V 2.1.00220191204

GOOD WE PROTOCOL

LV BMS Protocol(CAN) for Solar Inverter Family EN_V 1.5

PYLON PROTOCOL 2.0

Pylon CAN bus protocol V 2.0.420211122

SMA PROTOCOL

Precautions

◆ Power-On Measurement

PROTOCOL

CAN

SO FAR PROTOCOL

SoFar Energy BMS CAN V 2.1.00220191204

GOOD WE PROTOCOL

LV BMS Protocol(CAN) for Solar Inverter Family EN_V 1.5

PYLON PROTOCOL 2.0

Pylon CAN bus protocol V 2.0.420211122

SMA PROTOCOL

SMAFSS-Connecting Bat-TI-en-20W

GROWATT_PROTOCOL

Growatt BMS CAN-Bus-protocol-low-voltage-V 1.04

RS485

USER_485_VOLTRON

Voltronic Inverter and BMS BMS Communication protocol
20200325(1)

USER 485PYLON

RS485-protocol-pylon-low-voltage-V 3.5

USER_485_LUXPOWER

Lux power tek Battery Protocol Rs485_V 01

SYSTEM













PACK SN

LANGUAGE

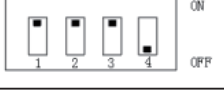
English

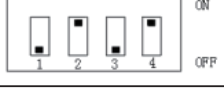
China

◆ ADS DIP SWITCH DEFINITIONS

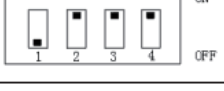
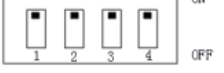
Address	DIP Switch Position				Illustration
	#1	#2	#3	#4	
0	OFF	OFF	OFF	OFF	
1	ON	OFF	OFF	OFF	
2	OFF	ON	OFF	OFF	
3	ON	ON	OFF	OFF	
4	OFF	OFF	ON	OFF	
5	ON	OFF	ON	OFF	
6	OFF	ON	ON	OFF	
7	ON	ON	ON	OFF	
8	OFF	OFF	OFF	ON	
9	ON	OFF	OFF	ON	
10	OFF	ON	OFF	ON	
11	ON	ON	OFF	ON	
12	OFF	OFF	ON	ON	
13	ON	OFF	ON	ON	
14	OFF	ON	ON	ON	
15	ON	ON	ON	ON	

◆ BATTERY PARALLEL CONNECTION DIP SWITCH DIAGRAM

1 Battery	2 Battery	3 Battery	4 Battery	5 Battery	6 Battery	7 Battery	8 Battery
9 Battery	10 Battery	11 Battery	12 Battery	13 Battery	14 Battery	15 Battery	16 Battery

◆ BATTERY PARALLEL CONNECTION DIP SWITCH DIAGRAM

◆ POWER-ON SEQUENCE

After the completion of the connections between the inverter, battery, and mains power, start each battery one by one. Then, turn on the inverter. After the battery startup, check if the communication between the inverter and the battery is normal. If the battery data is successfully uploaded to the inverter, it indicates successful communication between the inverter and the battery.

◆ COMMON ISSUES AND SOLUTIONS

No.	Fault Symptoms	Cause Analysis	Solution
1	No DC Output	Battery Voltage Too Low, Protection Activated	Startup after Charging Activation
2	Short Power Supply Time	Insufficient Battery Capacity or Failure to Reach Full Charge	Confirm Maintenance or Replace Battery
3	Battery Cannot Reach Full Charge	DC Voltage Output from Power System Lower than Minimum Charging Voltage	Adjust Device's DC Output Voltage to Suitable Charging Voltage for Battery
4	Unstable Battery Output Voltage with Significant Fluctuations	Interference with Management System Operation	Restart the System
5	Temperature Monitoring Too Low	Damage to Temperature-Sensing Crystal Head	Replace the Collection Line with a Temperature-Sensing Crystal Head
6	Unable to Charge	Single Cell Protection Activated upon Full Battery Charge	Discharge Protection Removal
7	MOS temperature abnormal	MOS tube damaged	Replace BMS
8	Discharge overcurrent protection	Inverter power exceeds limit	Match the number of batteries according to the inverter power value

◆ Inverter Matching Information

Inverter Brand	LOGO	Communication Method	Inverter Communication Pin	Battery Communication Pin	Remarks
Voltronic Power		RS485	PIN5:RS485A PIN3:RS485B	PIN2/7:RS485A PIN1/8:RS485B	1.Default Battery Protocol Matching 2.Customized Network Cable
VICTRON		CAN	PIN7:CANH PIN8:CANL	PIN4:CANH PIN5:CANL	1.Battery Protocol Change 2.Customized Network Cable
Growatt		RS485	PIN2:RS485A PIN1:RS485B	PIN2/7:RS485A PIN1/8:RS485B	1.Default Battery Protocol Matching 2.Inverter Protocol Setting Option 2
		CAN	PIN4:CANH PIN5:CANL	PIN4:CANH PIN5:CANL	
PYLONTECH		RS485	PIN7:RS485A PIN8:RS485B	PIN2/7:RS485A PIN1/8:RS485B	Default Battery Protocol Matching
GOODWE		CAN	PIN4:CANH PIN5:CANL	PIN4:CANH PIN5:CANL	Default Battery Protocol Matching
LUXPOWER		RS485	PIN2:RS485A PIN1:RS485B	PIN2/7:RS485A PIN1/8:RS485B	1.Battery Protocol Change 2.Customized Network Cable
SOFAR		CAN	PIN1:CANH PIN2:CANL	PIN4:CANH PIN5:CANL	1.Battery Protocol Change 2.Customized Network Cable
SRNE		RS485	PIN7:RS485A PIN8:RS485B	PIN2/7:RS485A PIN1/8:RS485B	1.Default Battery Protocol Matching 2.Inverter Protocol Setting PYL
Deye		RS485	PIN7:RS485A PIN8:RS485B	PIN2/7:RS485A PIN1/8:RS485B	Default Battery Protocol Matching
		CAN	PIN4:CANH PIN5:CANL	PIN4:CANH PIN5:CANL	
MEGAREVO		CAN	PIN4:CANH PIN5:CANL	PIN4:CANH PIN5:CANL	Default Battery Protocol Matching
MUST		CAN	PIN6:CANH PIN5:CANL	PIN4:CANH PIN5:CANL	1.Battery Protocol Change 2.Customized Network Cable
SMA		CAN	PIN4:CANH PIN5:CANL	PIN4:CANH PIN5:CAN	Battery Protocol Change

Maintenance

1. Do not immerse the battery in water. When not in use, store it in a cool and dry environment.
2. Do not throw the battery into the fire or heat it externally to avoid explosion or other hazards.
3. Do not invert the positive and negative poles of the battery. Never connect the battery directly to a power outlet, and prohibit short-circuiting the positive and negative poles.
4. Do not mix batteries from different manufacturers, different kinds, types, or different ages.
5. Do not use batteries that show signs of heating, swelling, information, or leakage in charging or discharging devices.
6. Prohibit piercing the battery with nails or other sharp objects, as well as throwing, stepping on, hitting, or impacting the battery.
7. Prohibit disassembling or dismantling the battery and its components. Any damage caused by unauthorized disassembly or repair will not be the responsibility of our company.
8. The battery undergoes strict inspection before leaving the factory. If customers find signs of heating, swelling, or unusual odors, do not use it and return it to the factory immediately.
9. For long-term storage, to ensure optimal battery performance, perform a charge-discharge cycle every three months and ensure a storage charge of 40%~60%.
10. Use the battery within the specified temperature range as stated in the specification.
11. Follow the specified power-up sequence for both the battery and the inverter.
12. If the battery is left unused for more than 3 months, it needs manual charging periodically to prevent complete discharge.

NOTE:

- In case of specific technical issues or situations not mentioned above, please contact technical support promptly.